

KEY FEATURES

- Switching Power Module for PCB Mountable
- Fully Encapsulated Plastic Case
- Universal Input Range 90-264VAC, 47-440 Hz
- Regulated Output
- Low Ripple and Noise
- CE, UL Approval
- 3-Year Product Warranty



ELECTRICAL SPECIFICATIONS

All specifications valid at normal input voltage, full load and +25°C after warm-up time unless otherwise stated.

Model No. (Single Output)	ATC-3.3S	ATC-5S	ATC-12S	ATC-15S	ATC-24S	
Max Output Wattage (W)	10W	10W	10W	10W	10W	
Input	Voltage					
	90-264 VAC or 120-370 VDC					
	Frequency (Hz)					
	47-440 Hz					
	Current (Full load)					
	200 mA max. (115 VAC) / 130 mA max. (230 VAC)					
Inrush Current (<2ms)						
10 A max. (115 VAC) / 20 A max. (230 VAC)						
Leakage Current						
0.75 mA max.						
External Fuse (recommend)						
1.5 A slow blow type						
Output	Voltage (V.DC.)	3.3V	5V	12V	15V	24V
	Voltage Accuracy	±2%				
	Current (mA) max	3000	2000	833	666	426
	Line Regulation (LL-HL) (typ.)	±0.5%				
	Load Regulation (5-100%) (typ.)	±1%				
	Minimum Load	4%	5%	5%	3%	5%
	Maximum Capacitive Load	70000 uF	35000 uF	11000 uF	7000 uF	2300 uF
	Ripple	<0.2% Vout +40mV max (Vp-p)				
	Noise	<0.5% Vout +50mV max (Vp-p)				
	Efficiency	65%	71%	76%	75%	76%
	Hold-up Time	15 ms min.				
Protection	Over Power Protection	Hiccup technique, auto-recovery				
	Over Voltage Protection	Zener diode clamp				
	Short Circuit Protection	Hiccup mode, indefinite (automatic recovery)				
Isolation	Input-Output (V.AC)	3000V				
	Input-FG (V.AC)	1500V				
	Output-FG (V.AC)	500V				
Environment	Operating Temperature	-25°C...+70°C (with derating)				
	Storage Temperature	-40°C...+85°C				
	Temperature Coefficient	±0.02%/°C				
	Humidity	95% RH				
	MTBF	>250,000 h @ 25°C (MIL-HDBK-217F)				
Physical	Dimension (L x W x H)	2.53 x 1.78 x 0.85 Inches (64.3 x 45.1 x 21.7 mm) Tolerance ±0.5 mm				
	Case Material	Plastic resin (flammability to UL 94V-0)				
	Weight	92 g				
	Cooling Method	Free air convection				
Safety	Agency Approvals	UL/cUL, CE				
EMC	EMI (Conducted & Radiated Emission)	EN 55032 class B				
	EMS (Noise Immunity)	EN 50082-1				

ELECTRICAL SPECIFICATIONS

All specifications valid at normal input voltage, full load and +25°C after warm-up time unless otherwise stated.

Model No. (Dual Output)	ATC-5D	ATC-12D	ATC-15D	
Max Output Wattage (W)	8W	10W	10W	
Input	Voltage			
	90-264 VAC or 120-370 VDC			
	Frequency (Hz)			
	47-440 Hz			
	Current (Full load)			
	200 mA max. (115 VAC) / 130 mA max. (230 VAC)			
Inrush Current (<2ms)				
10 A max. (115 VAC) / 20 A max. (230 VAC)				
Leakage Current				
0.75 mA max.				
External Fuse (recommend)				
1.5 A slow blow type				
Output	Voltage (V.DC.)	±5V	±12V	±15V
	Voltage Accuracy	±2%		
	Current (mA) max	±800	±380	±300
	Line Regulation (LL-HL) (typ.)	±0.5%		
	Load Regulation (5-100%) (typ.)	±1%		
	Minimum Load	1%	3%	1%
	Maximum Capacitive Load	±22000 uF	±3000 uF	±2000 uF
	Ripple	<0.2% Vout +40mV max (Vp-p)		
	Noise	<0.5% Vout +50mV max (Vp-p)		
	Efficiency	73%	75%	74%
	Hold-up Time	15 ms min.		
	Protection	Over Power Protection	Hiccup technique, auto-recovery	
Over Voltage Protection		Zener diode clamp		
Short Circuit Protection		Hiccup mode, indefinite (automatic recovery)		
Isolation	Input-Output (V.AC)	3000V		
	Input-FG (V.AC)	1500V		
	Output-FG (V.AC)	500V		
Environment	Operating Temperature	-25°C...+70°C (with derating)		
	Storage Temperature	-40°C...+85°C		
	Temperature Coefficient	±0.02%/°C		
	Humidity	95% RH		
	MTBF	>250,000 h @ 25°C (MIL-HDBK-217F)		
Physical	Dimension (L x W x H)	2.53 x 1.78 x 0.85 Inches (64.3 x 45.1 x 21.7 mm) Tolerance ±0.5 mm		
	Case Material	Plastic resin (flammability to UL 94V-0)		
	Weight	92 g		
	Cooling Method	Free air convection		
Safety	Agency Approvals	UL/cUL, CE		
EMC	EMI (Conducted & Radiated Emission)	EN 55032 class B		
	EMS (Noise Immunity)	EN 50082-1		

NOTE

1. Ripple & Noise are measured at 20MHz of bandwidth with 0.1uF & 47uF parallel capacitor.
2. It's recommended to add Varistor 14S471K at L / N input side in parallel.
3. Please refer to our PDF file "AC-DC Application" on our website: www.archcorp.com.tw

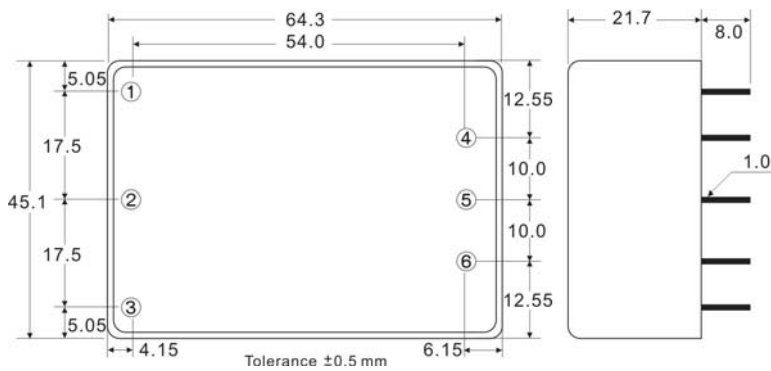
MECHANICAL DIMENSION (Top View)

PIN#	Single	Dual
1	FG	FG
2	AC IN (N)	AC IN (N)
3	AC IN (L)	AC IN (L)
4	-DC OUT	-DC OUT
5	NO PIN	COMMON
6	+DC OUT	+DC OUT

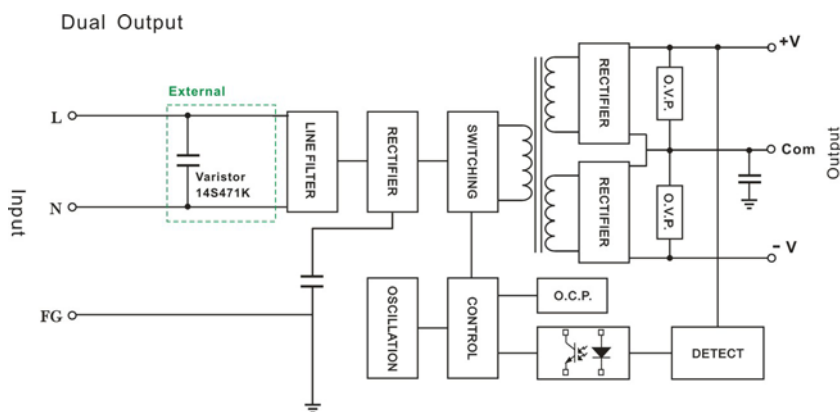
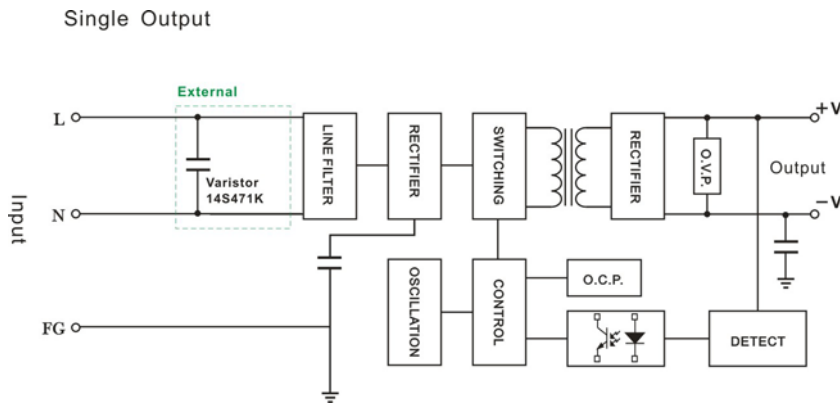
BLOCK DIAGRAM

DERATING
